

pannelli scorrevoli - porte

 **Hema**

**catalogo 05**

sliding doors - doors

Abitare è un linguaggio. Gli spazi di vita raccontano molto di noi, dei nostri desideri delle nostre abitudini. Racchiuse da preziose e sobrie cornici che delimitano gli ambienti in maniera discreta ed avvolgente, le porte Tema non sanno passare inosservate. Dotate di grande personalità sanno essere forti e delicate allo stesso tempo, solide ma anche raffinate. Porte che catturano e trattengono gli sguardi, protagoniste indiscusse dei vostri spazi di vita o di lavoro. Soluzioni perfette per chi ama vivere comodamente circondato da cose belle.

*The language of design. A living space can tell you much about ourselves, our desires, our habits. The cool clear lines of Temadoors define spaces discreetly without fuss creating a strong but refined framework for your living or working space. The perfect answer for people who want to live in comfort surrounded by beautiful things.*



*range of TEMA internal doors  
in a private residence  
Angeli Roberto - RICCIONE (RN)*

*realizzazioni con porte d'arredo TEMA  
in abitazione privata  
Angeli Roberto - RICCIONE (RN)*





45

90

45. taglio cornici a 45°  
frame 45°

90. taglio cornici a 90°  
frame 90°

**PORTA A BATTENTE**  
**HINGED DOOR**

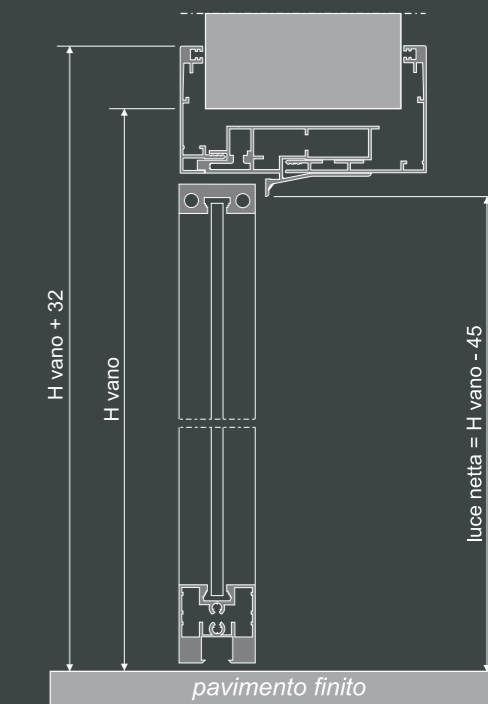
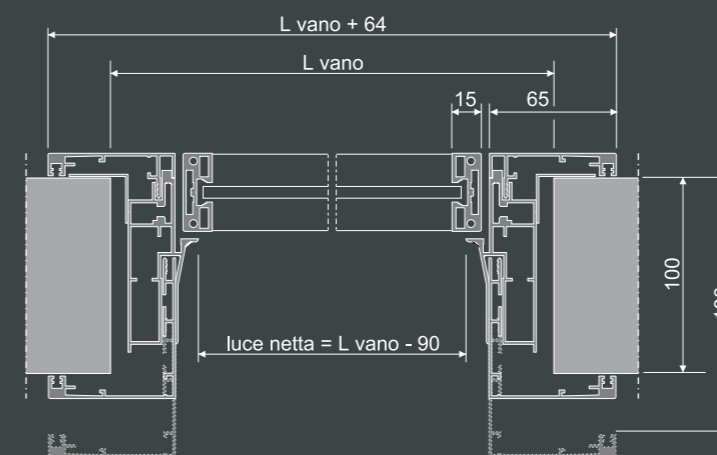

**PORTA SCORREVOLE A SCOMPARSA**  
**SLIDING DOOR FOR POCKET SYSTEM**

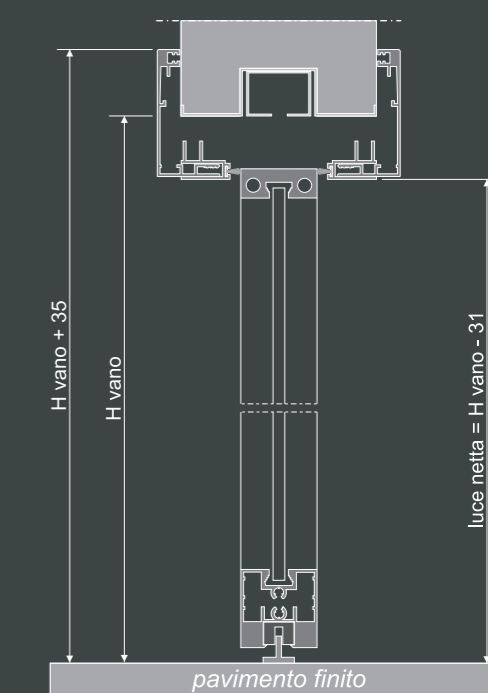
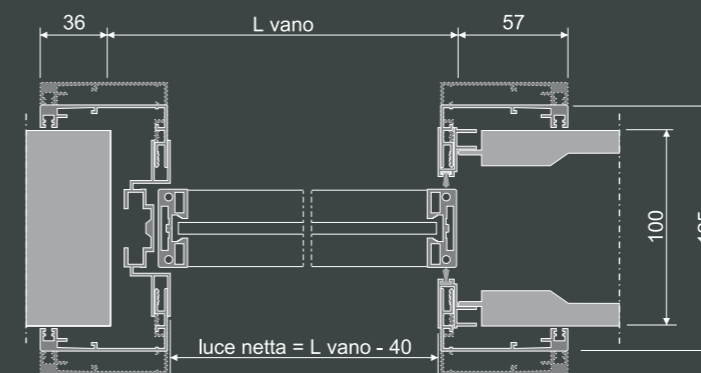





maniglia "clip" argento lucido  
 handle "clip" polished silver finish



**PLAN15 E/RS/NC**

quattro pannelli scorrevoli in alluminio/vetro  
 a raso soffitto con binario incassato  
**vetro** stratificato satinato nero  
**alluminio** argento lucido  
**maniglia** "clip" argento lucido

*four sliding aluminum/glass doors flush to the ceiling*  
**glass** laminated satin black  
**aluminium** polished silver finish  
**handle** "clip" polished silver finish



**PLAN15 E/RS/NC**

quattro pannelli scorrevoli  
in alluminio/vetro a raso  
soffitto con binario incassato  
**vetro** temprato trasparente  
**alluminio** nero  
**maniglia** "clip" nero

*four sliding aluminum/glass  
doors flush to the ceiling  
**glass** tempered clear  
**aluminium** black finish  
**handle** "clip" black finish*

**PLAN40 B/SF**

doppio pannello scorrevole  
in alluminio/vetro a  
soffitto con veletta in vista  
**vetro** temprato satinato bianco  
**alluminio** argento opaco  
**maniglia** "dado" argento opaco

*double sliding aluminum/glass  
doors ceiling mounted with fascia  
**glass** tempered satin white  
**aluminium** matt silver finish  
**handle** "dado" matt silver finish*

**maniglia** "olivari total" biocromo satinato con chiusura magnetica su adattatore orizzontale  
**handle** "olivari total" biochrome satin finish and horizontal adaptor with magnetic lock, black finish



Adattatore orizzontale

Adattatore HCS

Adattatore rettangolare

### PLAN BT-1

porta a battente con anta alluminio/vetro e stipite in alluminio  
**vetro** temprato satinato bianco  
**alluminio** bianco avorio  
**maniglia** "HCS 1880" con riporto bianco avorio su adattatore HCS

*hinged aluminum/glass door with aluminum frame*  
**glass** tempered satin white  
**aluminium** ivory finish  
**handle** "HCS 1880" and HCS adaptor ivory finish

**maniglia** "HCS 1880" con riporto bianco avorio su adattatore HCS  
**handle** "HCS 1880" and HCS adaptor ivory finish

**maniglia** "olivari planet Q" cromo opaco con chiusura magnetica su adattatore rettangolare argento opaco  
**handle** "olivari planet Q" matt chrome finish and rectangular adaptor with magnetic lock, matt silver finish

### PLAN BT-1

porta a battente con anta alluminio/vetro e stipite in alluminio  
**vetro** temprato satinato bianco  
**alluminio** argento opaco  
**maniglia** "HCS A197" argento opaco su adattatore HCS argento opaco

*hinged aluminum/glass door with aluminum frame*  
**glass** tempered satin white  
**aluminium** matt silver finish  
**handle** "HCS A197" and HCS adaptor matt silver finish





maniglia "jazz" cromo opaco  
handle "jazz" matt chrome finish



## PLAN BT-2

porta a doppio battente con  
anta alluminio/vetro  
e stipite in alluminio  
**vetro** temprato satinato bianco  
**alluminio** bianco avorio  
**maniglia** "jazz" cromo opaco

*double hinged aluminum/glass  
doors with aluminum frame  
glass tempered satin white  
aluminium ivory finish  
handle "jazz" matt chrome finish*



## PLAN BT-1

porta a battente con anta alluminio/vetro  
e stipite in alluminio  
**vetro** temprato trasparente  
**alluminio** nichel  
**maniglia** "olivari tecno" nichel con  
serratura magnetica su adattatore  
rettangolare nichel

*hinged aluminum/glass door  
with aluminum frame  
glass tempered clear  
aluminium nickel finish  
handle "olivari Tecno" and rectangular  
adaptor with magnetic lock, nickel finish*





**PLAN15 SC-1**

porta scorrevole a scomparsa con anta  
in alluminio/vetro e stipite in alluminio  
**vetro** stratificato opalino  
**alluminio** argento opaco  
**maniglia** "clip" argento opaco

*sliding aluminum/glass door for pocket  
system with aluminum frame  
**glass** laminated opal  
**aluminium** matt silver finish  
**handle** "clip" matt silver finish*





### PLAN15 SC-2

doppia porta scorrevole a scomparsa con ante in alluminio/vetro e stipite in alluminio  
**vetro** stratificato nero  
**alluminio** argento opaco  
**maniglia** "clip" argento opaco

*double sliding aluminum/glass doors for pocket system with aluminum frame*  
**glass** laminated black  
**aluminium** matt silver finish  
**handle** "clip" matt silver finish



### PLAN15 SC-1-CIRCULAR

porta scorrevole a scomparsa curva con ante in alluminio/vetro e stipite in alluminio  
**vetro** temprato satinato bianco  
**alluminio** argento opaco  
**maniglia** "dado" argento opaco

*circular sliding aluminum/glass door for pocket system with aluminum frame*  
**glass** tempered satin white  
**aluminium** matt silver finish  
**handle** "dado" matt silver finish



maniglia "dado" bianco avorio  
handle "dado" ivory finish



**PLAN15**  
**SC-2-PAN**

doppia porta scorrevole a scomparsa con ante in alluminio/vetro per cassonetti senza stipite  
**vetro** stratificato nero  
**alluminio** nero  
**maniglia** "lingotto" nera

*double sliding aluminum/glass door for unframed pocket system*  
**glass** laminated black  
**aluminium** black finish  
**handle** "lingotto" black finish

**PLAN15**  
**SC-1**

porta scorrevole a scomparsa con ante in alluminio/vetro e stipite in alluminio  
**vetro** temprato satinato bianco  
**alluminio** bianco avorio  
**maniglia** "dado" bianco avorio

*sliding aluminum/glass door for pocket system with aluminum frame*  
**glass** tempered satin white  
**aluminium** ivory finish  
**handle** "dado" ivory finish

**PLAN15**  
**SC-2/P**

porta scorrevole a scomparsa a due ante parallele in alluminio/vetro e stipite in alluminio  
**vetro** temprato satinato bianco  
**alluminio** bianco avorio  
**maniglia** "dado" bianco avorio

*double telescopic sliding aluminum/glass doors for pocket system with aluminum frame*  
**glass** tempered satin white  
**aluminium** ivory finish  
**handle** "dado" ivory finish





**maniglia** "cetra" e "dado con serratura" argento lucido  
**handle** "cetra" and "dado with lock" polished silver finish

### PLAN15 BL

porta a bilico con ante in alluminio/vetro senza stipite **vetro** temprato grigio trasparente **alluminio** argento opaco **maniglia** "olivari planet Q" cromo opaco con chiusura magnetica su adattatore orizzontale.

*pivot aluminum/glass door with aluminum frame **glass** tempered clear grey **aluminium** matt silver finish **handle** "olivari planet Q" and horizontal adaptor with magnetic lock, matt chrome finish*

### PLAN LIBRO-2

porta a libro con ante in alluminio/vetro e stipite in alluminio **vetro** stratificato opalino **alluminio** argento lucido **maniglia** "cetra" e "dado con serratura" argento lucido

*folding aluminum/glass doors with aluminum frame **glass** laminated opal **aluminium** polished silver finish **handle** "cetra" and "dado with lock" polished silver finish*



cerniera superiore  
upper hinge

cerniera superiore  
upper hinge



## PLAN BT-1-WMIX-PAN

porta a battente con anta in alluminio/vetro e stipite in legno  
**vetro** temprato satinato bronzo  
**alluminio** nichel  
**maniglia** "olivari tecno" nichel con serratura magnetica su adattatore rettangolare nichel  
**stipite** in legno impiallacciato rovere tinto wengé

*hinged aluminum/glass door with wood frame*  
**glass** tempered satin bronze  
**aluminium** nikel finish  
**handle** "olivari Tecno" and rectangular adaptor with magnetic lock, nickel finish  
**frame** veneer wengé oak wood

## PLAN BT-1-WMIX-AL

porta a battente con anta in legno e stipite in alluminio  
**anta** in legno impiallacciato rovere sbiancato  
**stipite** alluminio nichel  
**maniglia** "olivari planet Q" nichel con serratura magnetica

*hinged wood door with aluminium frame*  
**door** veneer bleached oak wood  
**aluminium frame** nickel finish  
**handle** "olivari planet Q" with magnetic lock, nickel finish





**PORTA A BATTENTE**  
**HINGED DOOR**

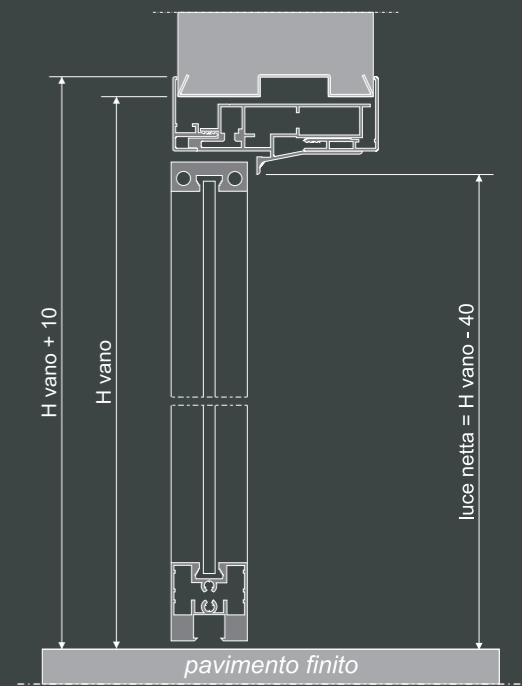
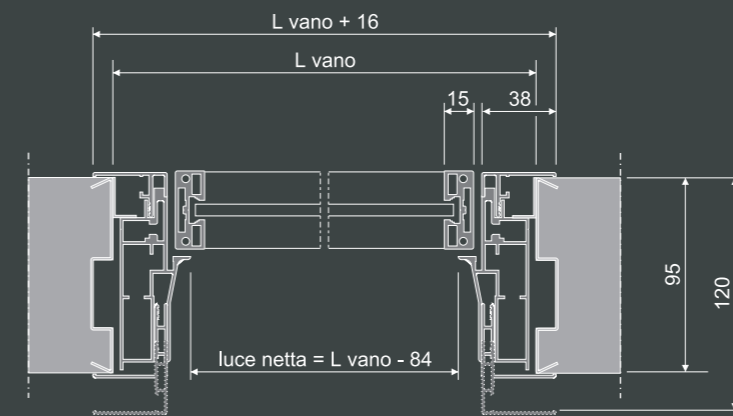

**PORTA SCORREVOLE A SCOMPARS**  
**SLIDING DOOR FOR POCKET SYSTEM**

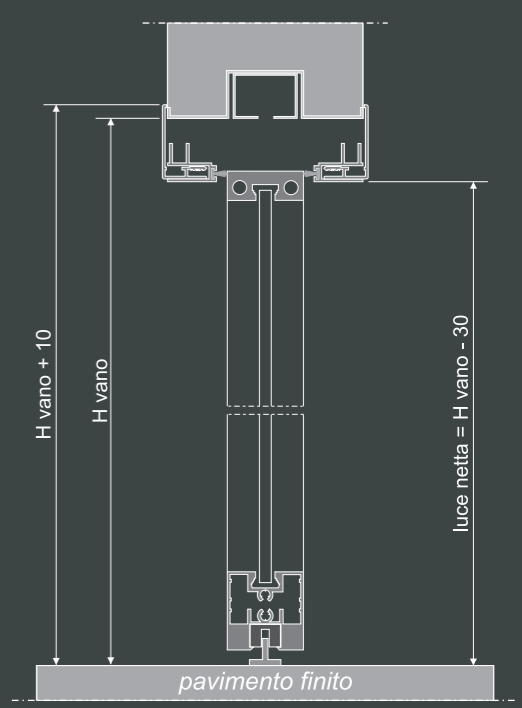
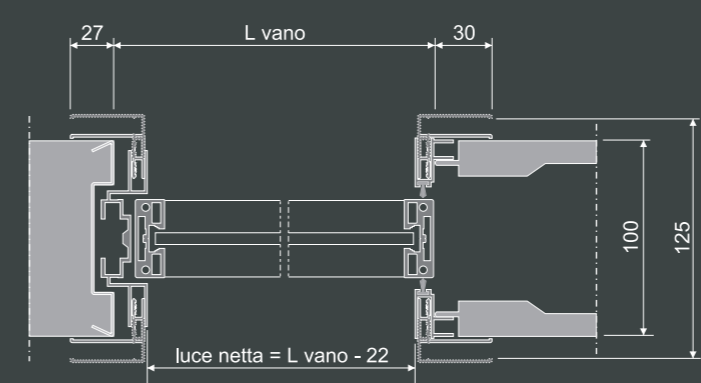



**maniglia** "olivari total" biocromo satinato con chiusura magnetica su adattatore orizzontale  
**handle** "olivari total" biochrome satin finish and horizontal adaptor with magnetic lock, black finish



**maniglia** "olivari total" biocromo satinato con serratura magnetica su adattatore rettangolare  
**handle** "olivari total" biochrome satin finish and rectangular adaptor with magnetic lock, black finish

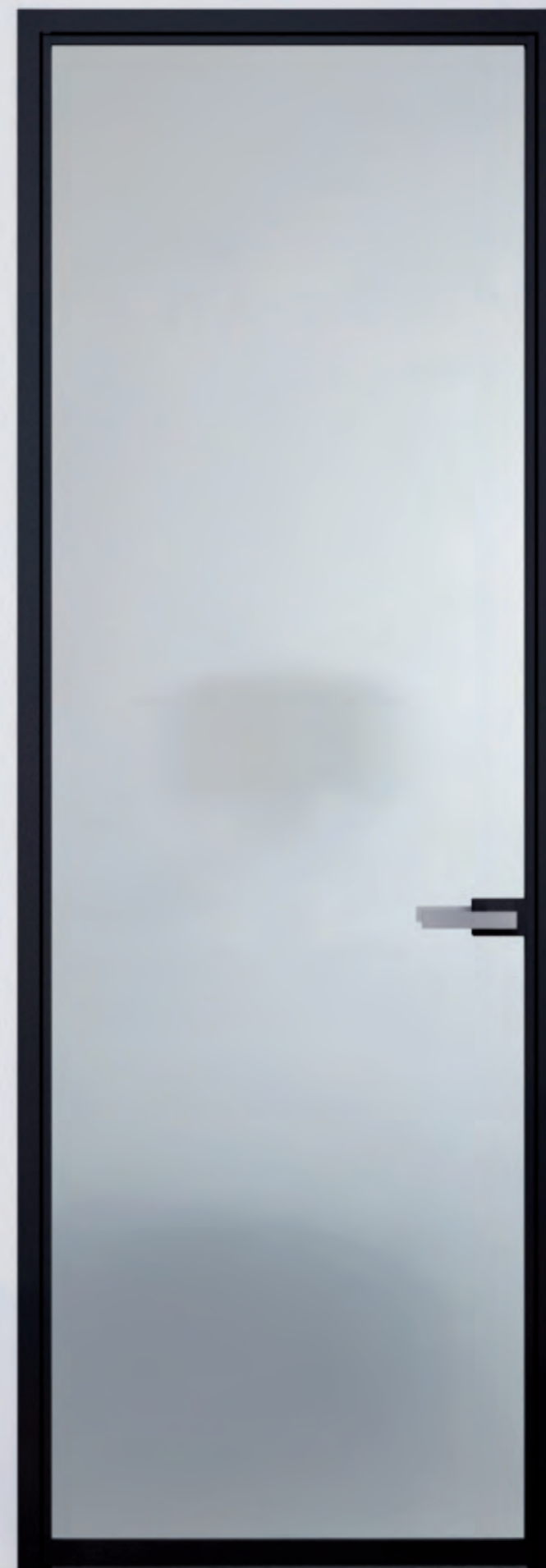

## SLIM BT-1

porta a battente con anta alluminio/vetro e stipite in alluminio  
**vetro** temprato satinato bianco  
**alluminio** nero  
**maniglia** "olivari total" biocromo satinato con chiusura magnetica su adattatore orizzontale nero

*hinged aluminum/glass door with aluminum frame*  
**glass** tempered satin white  
**aluminium** black finish  
**handle** "olivari total" biochrome satin finish and horizontal adaptor with magnetic lock, black finish





**SLIM**  
**FS-COR-4**

pannello fisso in alluminio/vetro  
 e stipite in alluminio su 4 lati  
**vetro** temprato trasparente  
**alluminio** argento opaco

*fixed aluminum/glass panel  
 with 4 sides aluminum frame  
**glass** tempered clear  
**aluminium** matt silver finish*



**maniglia** "HEWI-serie 120"  
 bianca con serratura magnetica  
 su adattatore rettangolare bianco  
**handle** iHEWI-serie 120i and  
 rectangular adaptor with  
 magnetic lock, white finish

**SLIM**  
**BT-1**

porta a battente con anta alluminio/vetro  
 e stipite in alluminio  
**vetro** stratificato bianco  
**alluminio** bianco  
**maniglia** "HEWI-serie 120" bianca  
 con serratura magnetica  
 su adattatore rettangolare bianco

*hinged aluminum/glass door  
 with aluminum frame  
**glass** laminated white  
**aluminium** white finish  
**handle** "HEWI-serie 120" and  
 rectangular adaptor with  
 magnetic lock, white finish*

**maniglia** "olivari total" biocromo  
 satinato con serratura  
 magnetica su adattatore  
 rettangolare argento opaco

**handle** "olivari total" biochrome  
 satin finish and rectangular  
 adaptor with magnetic lock,  
 matt silver finish

**SLIM**  
**BT-1**

porta a battente con anta alluminio/vetro e stipite in alluminio  
**vetro** temprato trasparente  
**alluminio** argento opaco  
**maniglia** "olivari total" biocromo satinato con serratura  
 magnetica su adattatore rettangolare argento opaco

*hinged aluminum/glass door with aluminum frame  
**glass** tempered clear  
**aluminium** matt silver finish*

**handle** "olivari total" biochrome satin finish and rectangular  
 adaptor with magnetic lock, matt silver finish





**maniglia** "lingotto" argento opaco  
**handle** "lingotto" matt silver finish



**maniglia** "lingotto con serratura" argento opaco  
**handle** "lingotto with lock" matt silver finish



## SLIM SC-1

porta scorrevole a scomparsa con anta in  
 alluminio/vetro e stipite in alluminio  
**vetro** temprato satinato bianco  
**alluminio** argento opaco  
**maniglia** "lingotto" e "lingotto con serratura"  
 argento opaco

*sliding aluminum/glass door for pocket  
 system with aluminum frame  
**glass** tempered satin white  
**aluminium** matt silver finish  
**handle** "lingotto" and "lingotto with lock"  
 matt silver finish*







**maniglia "dado" nera**  
**handle "dado" black finish**



**SLIM**  
**SC-1**

porta scorrevole a scomparsa  
con anta in alluminio/vetro  
e stipite in alluminio  
**vetro** temprato grigio trasparente  
**alluminio** nero  
**maniglia** "lingotto" nera

*sliding aluminum/glass door  
for pocket system with  
aluminum frame  
**glass** tempered clear grey  
**aluminium** black finish  
**handle** "lingotto" black finish*

**SLIM**  
**SC-1**

porta scorrevole a scomparsa  
con anta in alluminio/vetro e  
stipite in alluminio  
**vetro** temprato grigio trasparente  
**alluminio** nero  
**maniglia** "dado" nera

*sliding aluminum/glass  
door for pocket system  
with aluminum frame  
**glass** tempered clear grey  
**aluminium** black finish  
**handle** "dado" black finish*





**maniglia** "ala" e "ala con serratura"  
argento opaco  
**handle** "ala" and "ala with lock" mat  
silver finish



## SLIM LIBRO-2

porta a libro con ante in alluminio/vetro  
e stipite in alluminio  
**vetro** temprato satinato bianco  
**alluminio** argento opaco  
**maniglia** "ala" e "ala con serratura"  
argento opaco

*folding aluminum/glass doors  
with aluminum frame  
glass tempered satin white  
aluminium matt silver finish  
handle "ala" and "ala with lock"  
matt silver finish*

## SLIM BT-1-WMIX-AL

porta a battente con anta in  
legno e stipite in alluminio  
**anta** in legno laccata bianco lucido  
**stipite** alluminio nichel  
**maniglia** "olivari planet Q"  
nichel con serratura magnetica

*hinged wood door with  
aluminium frame  
door gloss white lacquered wood  
aluminium frame nickel finish  
handle olivari planet Q with  
magnetic lock, nickel finish*



**PORTA A BATTENTE**  
**HINGED DOOR**

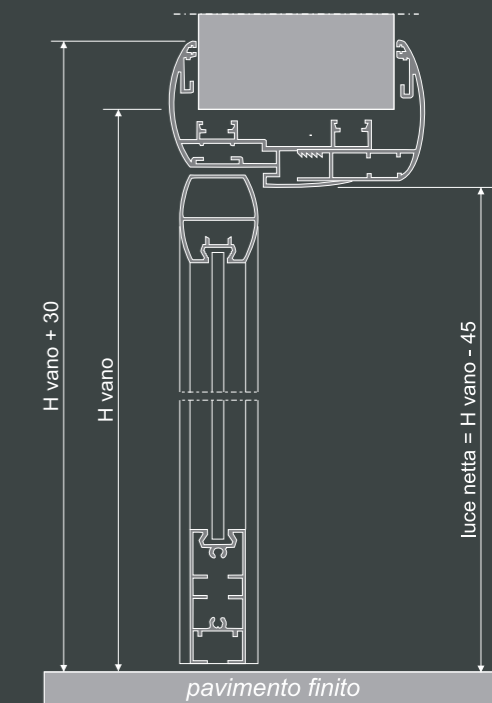
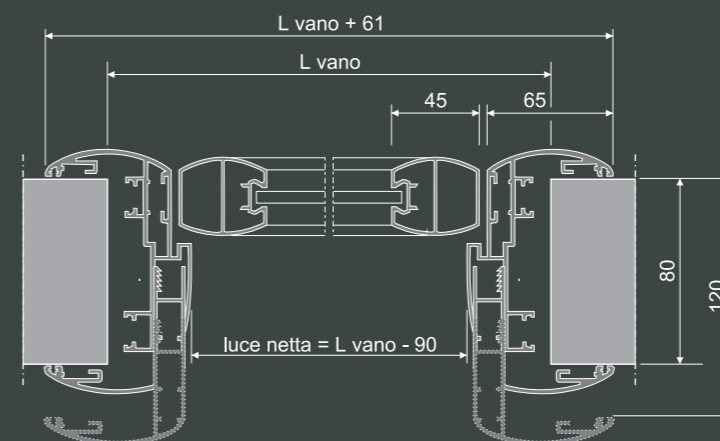

**PORTA SCORREVOLE A SCOMPARSA**  
**SLIDING DOOR FOR POCKET SYSTEM**

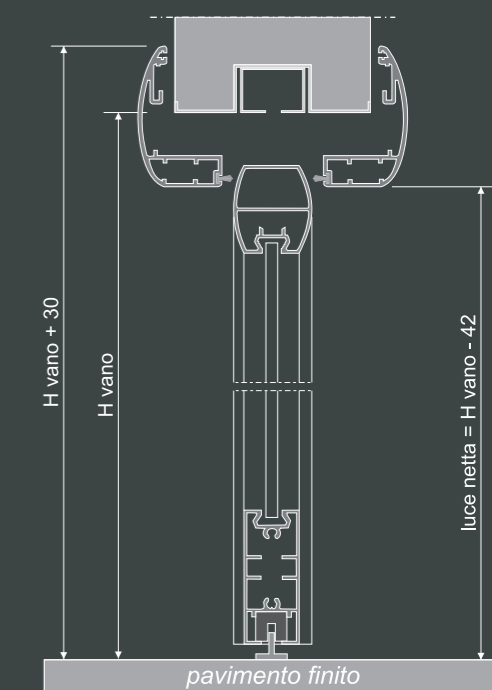
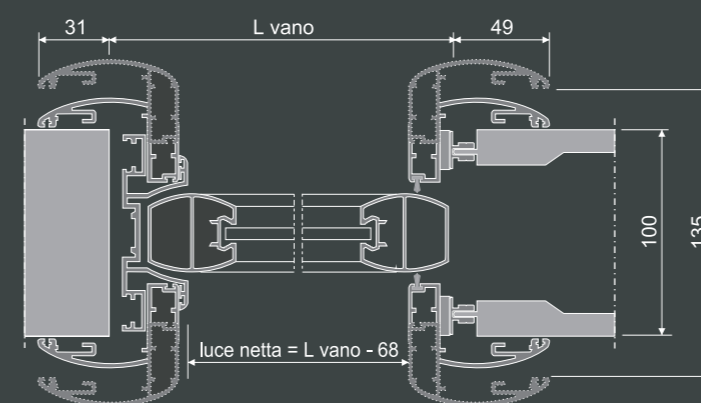





## SOFT E/SF/NC

quattro pannelli scorrevoli in alluminio/vetro  
a soffitto con veletta in vista  
**vetro** stratificato opalino  
**alluminio** argento opaco  
**maniglia** "flauto" argento opaco

*four sliding aluminum/glass doors ceiling  
mounted with fascia  
**glass** laminated opal  
**aluminium** matt silver finish  
**handle** "flauto" matt silver finish*



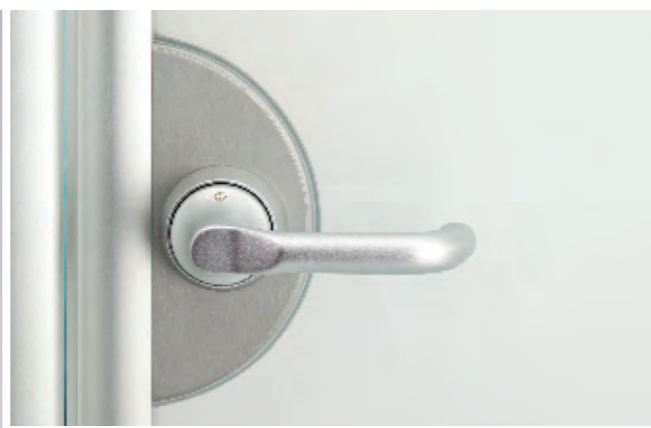

**maniglia** "HCS A138" argento opaco su adattatore HCS argento opaco  
**handle** "HCS A138" and HCS adaptor matt silver finish



**maniglia** "olivari aurelia" cromo opaco con serratura magnetica su adattatore trapezoidale argento opaco  
**handle** "olivari aurelia" mat chrome finish and trapezoidal adaptor with magnetic lock, matt silver finish



**SOFT  
BT-1**

porta a battente con anta alluminio/vetro e stipite in alluminio  
**vetro** temprato satinato bianco  
**alluminio** argento opaco  
**maniglia** "HCS A138" argento opaco su adattatore HCS argento opaco

*hinged aluminum/glass door with aluminum frame  
glass tempered satin white  
aluminium matt silver finish  
handle "HCS A138" and HCS adaptor matt silver finish*

**SOFT  
SC-1**

porta scorrevole a scomparsa con anta in alluminio/vetro e stipite in alluminio  
**vetro** temprato satinato bianco  
**alluminio** argento opaco  
**maniglia** "arco" argento opaco

*sliding aluminum/glass door for pocket system with aluminum frame  
glass tempered satin white  
aluminium matt silver finish  
handle "arco" matt silver finish*



**SOFT  
LIBRO-2**

porta a libro con ante in alluminio/vetro e stipite in alluminio  
**vetro** stratificato blu notte  
**alluminio** argento opaco  
**maniglia** "armonica" argento opaco

*folding aluminum/glass doors with aluminum frame  
 glass laminated blue night  
 aluminium matt silver finish  
 handle "armonica" matt silver finish*

**SOFT  
BT-1-WMIX-AL**

porta a battente con anta in legno e stipite in alluminio  
**anta** in legno impiallacciato rovere wengé  
**stipite alluminio** argento opaco  
**maniglia** "olivari aurelia" cromo opaco con serratura magnetica

*hinged wood door with aluminium frame  
 door veneer wengé oak wood  
 aluminium frame matt silver finish  
 handle "olivari aurelia" with magnetic lock matt chrome finish*

**SOFT  
BT-1-WMIX-PAN**

porta a battente con anta in alluminio/vetro e stipite in legno  
**vetro** stratificato opalino  
**alluminio** argento opaco  
**maniglia** "HCS A138/SK" argento opaco su adattatore HCS argento opaco  
**stipite** in legno impiallacciato rovere tinto wengé

*hinged aluminum/glass door with wood frame  
 glass laminated opal  
 aluminium matt silver finish  
 handle "HCS A138/SK" and HCS adaptor matt silver finish  
 frame veneer wengé oak wood*

maniglie per ante in ALLUMINIO/VETRO PLAN-15, PLAN-40, SLIM : pannelli scorrevoli - porte scorrevoli a scomparsa - porte a libro  
 ALUMINIUM/GLASS doors handles PLAN-15, PLAN-40, SLIM : sliding doors - sliding doors for pocket system - folding doors



dado



dado con serratura  
 dado with lock



lingotto con serratura  
 lingotto with lock

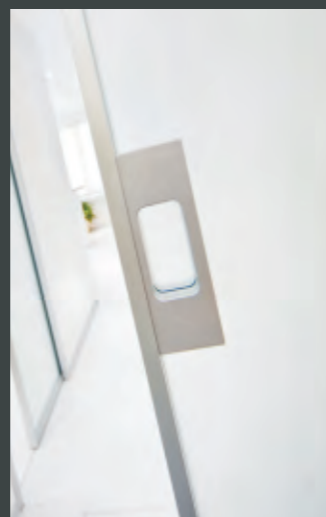

lingotto



ala

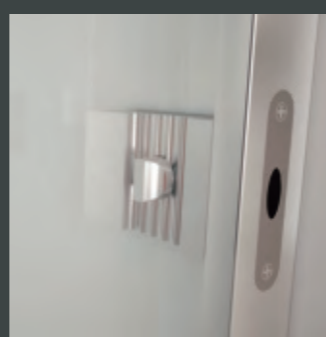

ala con serratura  
 ala with lock

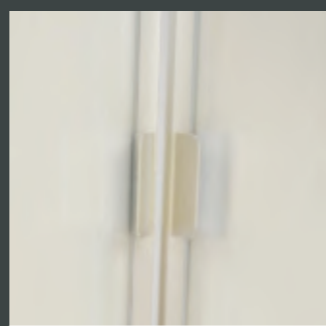

cetra

clip

maniglie hoppe HCS per PORTE A BATTENTE  
 hoppe HCS HINGED DOORS handles



hoppe HCS 1880



hoppe HCS A197



hoppe HCS A138

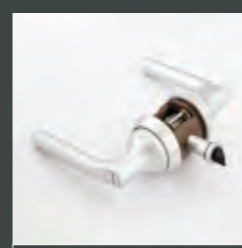

SK nottolino/bottone  
 latch/button

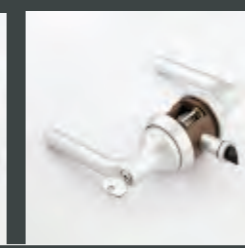

15 nottolino/chiave  
 latch/key



15/15 chiave/chiave  
 key/key

combinazioni di chiusura applicabili su tutte le maniglie hoppe HCS  
 combination lock for hoppe HCS handles

maniglie tradizionali per PORTE A BATTENTE  
 traditional HINGED DOORS handles



hewi-serie 120



olivari total



olivari planet Q



olivari tecno



olivari aurelia



reguitti q-arte

maniglie per ante in ALLUMINIO/VETRO SOFT : pannelli scorrevoli - porte scorrevoli a scomparsa - porte a libro  
 ALUMINIUM/GLASS doors handles SOFT : sliding doors - sliding doors for pocket system - folding doors



flauto



arco



arpa



arpa con serratura  
 arpa with lock



armonica



**plan**

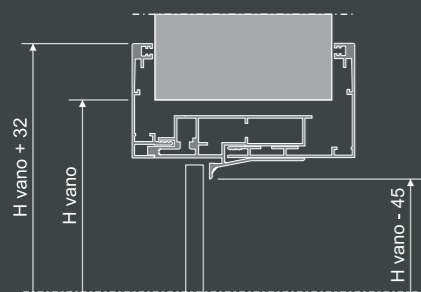
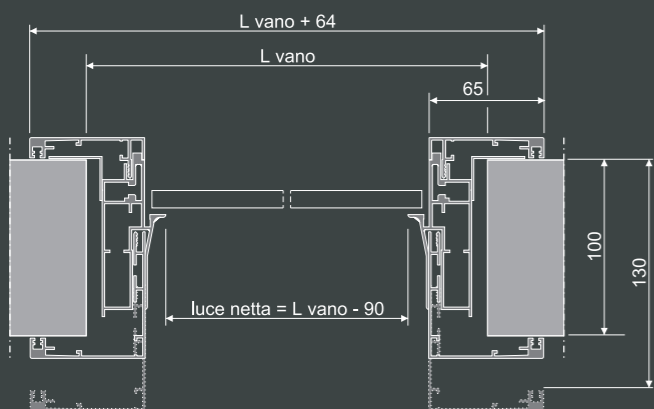

**slim**

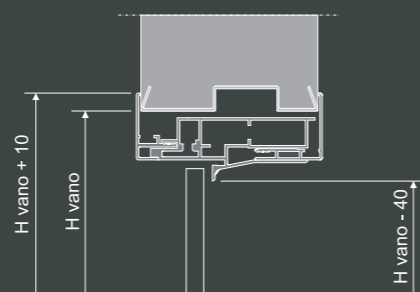
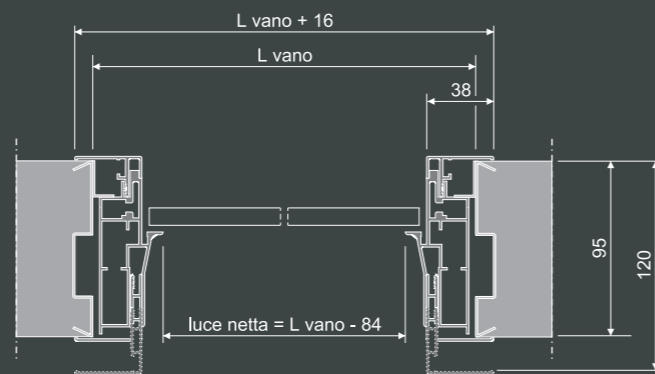

**soft**

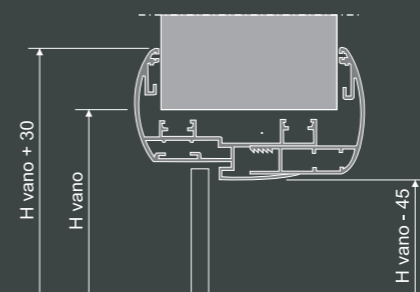
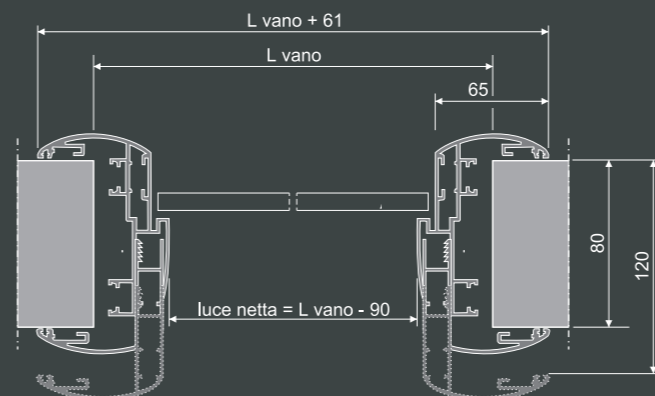

PORTA A BATTENTE - HINGED DOOR

PORTA SCORREVOLE A SCOMPARSA  
SLIDING DOOR FOR POCKET SYSTEM

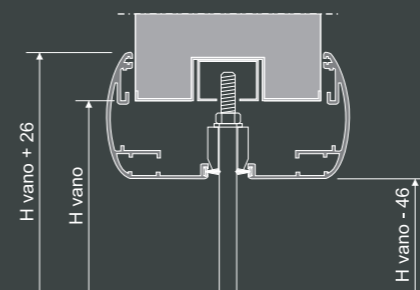
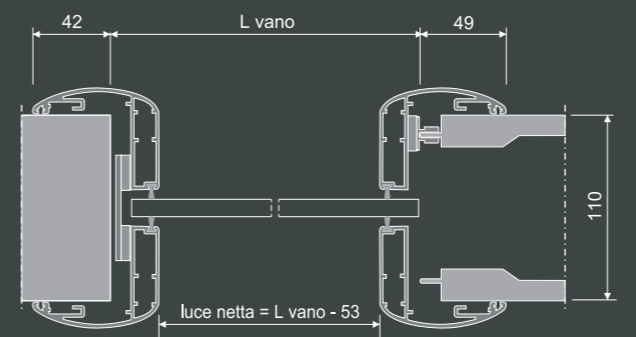
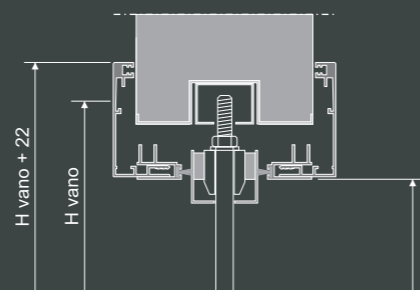
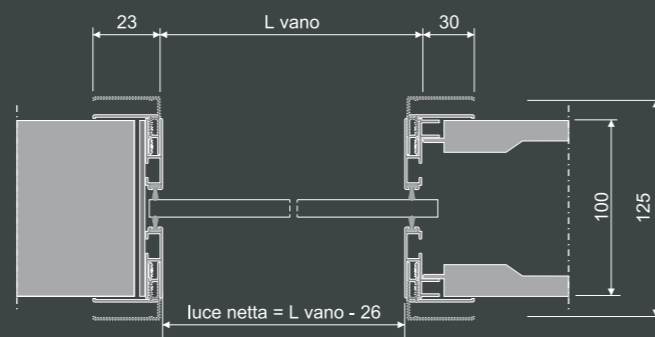
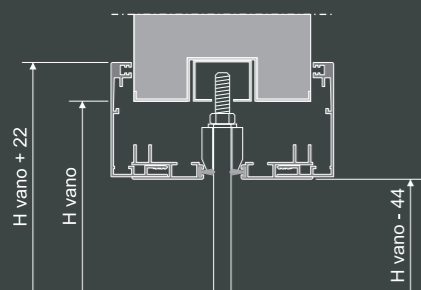
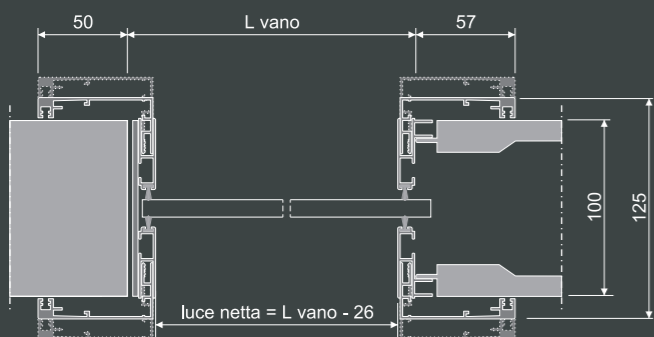





## INOX SLIDE B/PT

doppio pannello scorrevole in vetro con binario  
e accessori di scorrimento in vista a parete  
**vetro** 10 mm. temprato satinato bronzo  
**sistema di scorrimento** acciaio inox  
**maniglia** "stilo 1200" acciaio inox

*double sliding frameless glass doors with stainless  
steel bar and hangers  
glass 10 mm. thick, tempered satin bronze  
sliding system stainless steel  
handle "stilo 1200" stainless steel*



**sistema di scorrimento** acciaio inox  
*sliding system stainless steel*

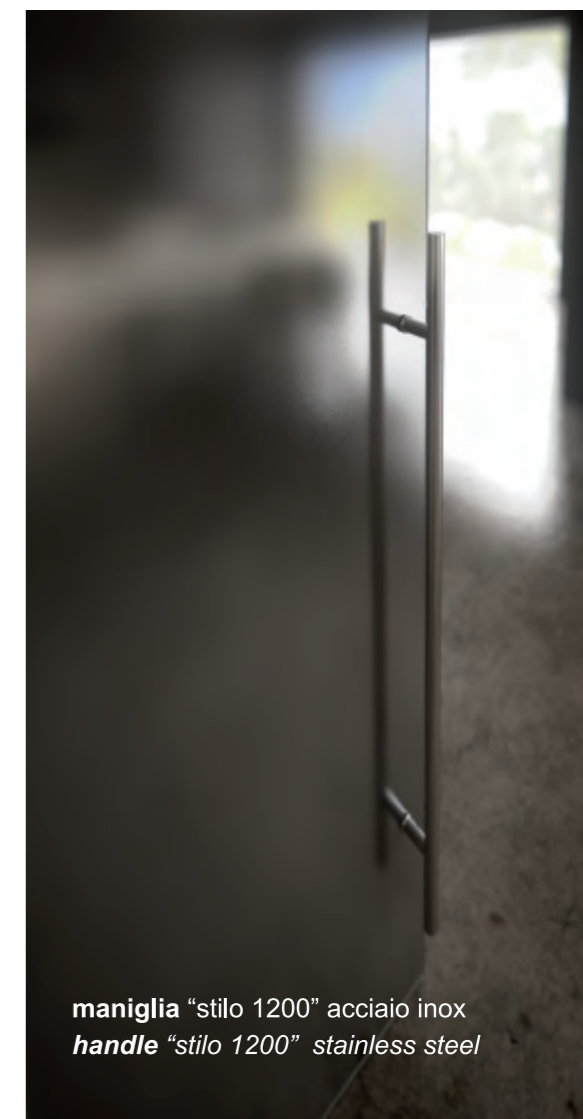

**maniglia** "stilo 1200" acciaio inox  
*handle "stilo 1200" stainless steel*





## SLACK E/SF/NC

due pannelli scorrevoli e due fissi  
in vetro a soffitto con veletta in vista  
**vetro** 10 mm. temprato trasparente  
**sistema di scorrimento** argento  
opaco h 103 mm.  
**maniglia** "bridge 400" argento opaco

*double sliding frameless glass doors  
and two fixed frameless glass panels  
with ceiling attachment and fascia  
glass 10 mm. thick, tempered clear  
sliding system matt silver finish –  
h 103 mm.  
handle "bridge 400" matt silver finish*

## FLO B/PT

doppio pannello scorrevole in vetro con veletta  
in vista a parete  
**vetro** 10 mm. temprato trasparente  
**sistema di scorrimento** argento opaco – h 55 mm.  
**maniglia** "5BN0" argento opaco

*double sliding frameless glass doors with wall  
mounted track and fascia  
glass 10 mm. thick, tempered clear  
sliding system matt silver finish – h 55 mm.  
handle "5BN0" matt silver finish*

**maniglia** "5BN0" argento opaco  
**handle** "5BN0" matt silver finish

## FLO A/PT

un pannello scorrevole in vetro con veletta  
in vista a parete  
**vetro** 10 mm. temprato trasparente  
**sistema di scorrimento** argento opaco – h 55 mm.  
**Maniglia** "5BN0" argento opaco

*single sliding frameless glass doors with  
wall mounted track and fascia  
glass 10 mm. thick, tempered clear  
sliding system matt silver finish – h 55 mm.  
handle "5BN0" matt silver finish*





## FOLDING DIV-FAST-LIB6

divisorio pieghevole in vetro  
**vetro** 10 mm. temprato satinato bianco  
**maniglia** "B94 con nottolino di chiusura"  
 argento opaco

*folding sliding glass door divider*  
**glass** 10 mm. thick, tempered satin white  
**handle** "B94 with locking latch" matt  
 silver finish





cerniere "8665" argento  
hinge "8665" silver finish



*hinged frameless glass door  
with aluminum frame  
glass 10 mm. thick tempered satin white  
aluminium matt silver finish  
handle "HCS A197" matt silver  
finish and HCS adaptor 6730,  
matt silver finish  
hinge "8665" silver finish*



## PLAN BT-1-EASY

porta a battente con anta in vetro  
a muro senza stipite  
vetro 10 mm. temprato satinato bianco  
maniglia "bridge 200" argento opaco  
cerniere "8630" argento con apertura  
automatica 0°+90°-90°

*hinged frameless glass door  
without frame  
glass 10 mm. thick tempered satin white  
handle "bridge 200" matt silver finish  
hinge "8630" silver finish with automatic  
opening 0°+90°-90°*

## PLAN BT-1-FAST

porta a battente con anta in vetro e  
stipite in alluminio  
vetro 10 mm. temprato satinato bianco  
alluminio argento opaco  
maniglia "HCS A197" argento opaco  
su adattatore 6730 argento  
cerniere "8665" argento





**cerniere "triloba" nera**  
*hinge "triloba" black finish*



**cerniere "flexa" nera**  
*hinge "flexa" black finish*



**maniglia "flexa" su adattatore "flexa" nero**  
*handle "flexa" and "flexa adaptor" black finish*



### SLIM BT-1-FAST

porta a battente con anta in vetro e stipite in alluminio  
**vetro** 5+5 mm. temprato e stratificato nero  
**alluminio** nero  
**maniglia** "flexa" su adattatore "flexa" nero  
**cerniere** "flexa" nera

*hinged frameless glass door with aluminum frame*  
**glass** 5+5 mm. thick tempered and laminated black  
**aluminium** black finish  
**handle** "flexa" and "flexa adaptor" black finish  
**hinge** "flexa" black finish





**maniglione** "stilo 500" acciaio inox  
**handle** "stilo 500" stainless steel

**SLIM****BT-2-FAST-180 $\infty$** 

porta a doppio battente con ante in vetro e stipite in alluminio  
**vetro** 10 mm. temprato sabbizzato monofacciale con decoro personalizzato trasparente  
**alluminio** argento opaco  
**maniglia** "stilo 500" acciaio inox  
**cerniere** "8630" apertura automatica 0°+90°-90° argento

*double hinged frameless glass door with aluminum frame*  
**glass** 10 mm. thick tempered sanblasted on one side with clear custom decor  
**aluminium** matt silver finish  
**handle** "stilo 500" stainless steel  
**hinge** "8630" automatic opening 0°+90°-90° silver finish

**SLIM****BT-1-FAST-180 $\infty$** 

porta a battente con anta in vetro e stipite in alluminio  
**vetro** 10 mm. temprato satinato bianco  
**alluminio** argento opaco  
**maniglione** "stilo 500" acciaio inox  
**cerniere** "8630" apertura automatica 0°+90°-90° argento

*hinged frameless glass door with aluminum frame*  
**glass** 10 mm. thick tempered satin white  
**aluminium** matt silver finish  
**handle** "stilo 500" stainless steel  
**hinge** "8630" automatic opening 0°+90°-90° silver finish





## SOFT BT-1-FAST

porta a battente con anta in vetro e stipite in alluminio

**vetro** 10 mm. temprato e stratificato arancio

**alluminio** argento opaco

**maniglia** "HCS A138" argento opaco su

adattatore 6731 argento

**cerniere** "8664" argento

*hinged frameless glass door with aluminum frame*

**glass** 10 mm. thick tempered and laminated

*orange*

**aluminium** matt silver finish

**handle** "HCS A138" matt silver finish and HCS

*adaptor 6731, silver finish*

**hinge** "8664" silver finish





## PLAN SC-2-FAST

doppia porta scorrevole a scomparsa con ante in vetro e stipite in alluminio  
**vetro** 10 mm. temprato trasparente con disegno "la fascia" sabbiato monofacciale  
**alluminio** nichel  
**maniglia** "bridge 400" nichel

*double sliding frameless glass doors for pocket system with aluminum frame*  
**glass** 10 mm. thick tempered clear with sandblasted on one side decoration "la fascia"  
**aluminium** nikel finish  
**handle** "bridge 400" nickel finish



## PLAN SC-1-FAST-CIRCULAR

porta scorrevole a scomparsa curva con ante in vetro e stipite in alluminio  
**vetro** 10 mm. temprato satinato bianco  
**alluminio** argento opaco  
**maniglia** "bridge 200" argento opaco

*circular sliding glass door for pocket system with aluminum frame*  
**glass** 10 mm. thick, tempered satin white  
**aluminium** matt silver finish  
**handle** "bridge 200" matt silver finish





### SLIM SC-1-FAST

porta scorrevole a scomparsa con anta in vetro e stipite in alluminio  
**vetro** 5+5 mm. temprato e stratificato satinato blu  
**alluminio** argento opaco  
**maniglia** "B93" argento opaco

*sliding frameless glass doors for pocket system with aluminum frame  
**glass** 5+5 mm. thick tempered and laminated satin blue finish  
**aluminium** matt silver finish  
**handle** "B93" matt silver finish*



**maniglia** "jazz" cromo opaco  
**handle** "jazz" matt chrome finish



### SOFT SC-1-FAST

porta scorrevole a scomparsa con  
 anta in vetro e stipite in alluminio  
**vetro** 10 mm. temprato satinato bianco  
**alluminio** argento opaco  
**maniglia** "jazz" cromo opaco

*sliding frameless glass door for  
 pocket system with aluminum frame  
**glass** 10 mm. thick tempered satin white  
**aluminium** matt silver finish  
**handle** "jazz" matt chrome finish*





**PLAN  
LIBRO-2-FAST**

porta a libro con ante in vetro e stipite in alluminio  
**vetro** 10 mm. temprato satinato bianco  
**alluminio** argento opaco  
**maniglia** "B94 con nottolino di chiusura" argento opaco

*folding frameless glass door with aluminum frame  
**glass** 10 mm. thick tempered satin white  
**aluminium** matt silver finish  
**handle** "B94 with locking latch" matt silver finish*



**maniglia** "B94 con nottolino di chiusura"  
 argento opaco  
**handle** "B94 with locking latch" matt  
 silver finish



**SLIM  
LIBRO-2-FAST**

porta a libro con ante in vetro e stipite  
 in alluminio  
**vetro** 10 mm. temprato satinato bianco  
**alluminio** argento opaco  
**maniglia** "B94 con nottolino di chiusura"  
 argento opaco

*folding frameless glass door with  
 aluminum frame  
**glass** 10 mm. thick tempered satin white  
**aluminium** matt silver finish  
**handle** iB94 with locking latch  
 matt silver finish*





**SOFT LIBRO-2-FAST**

porta a libro con ante in vetro e stipite in alluminio  
**vetro** 10 mm. temprato satinato bianco  
**alluminio** argento opaco  
**maniglia** "B94 con nottolino di chiusura" argento opaco

*folding frameless glass doors with aluminum frame*  
*glass* 10 mm. thick tempered satin white  
*aluminium* matt silver finish  
*handle* "B94 with locking latch" matt silver finish

maniglie per ante in VETRO FAST, EASY : pannelli scorrevoli - porte scorrevoli a scomparsa - porte a battente - porte a libro  
 GLASS doors handles FAST, EASY : sliding doors - sliding doors for pocket system - hinged doors - folding doors

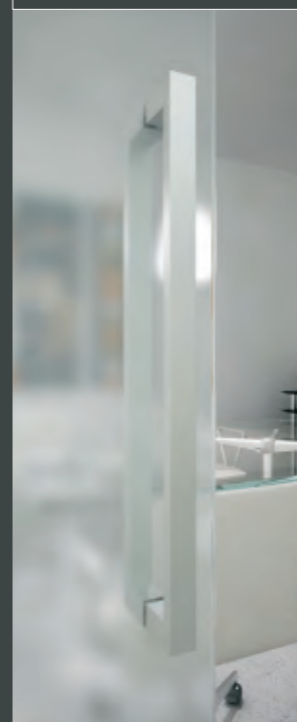

bridge 400

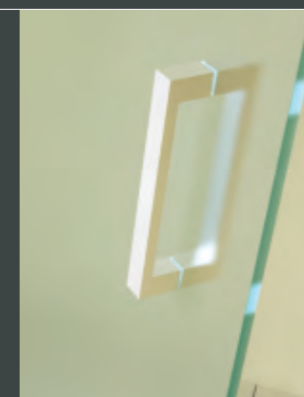

bridge 200



B94 con serratura  
 B94 with lock

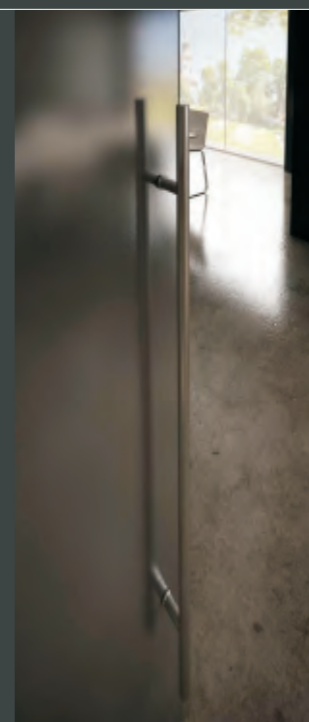

stilo 1200

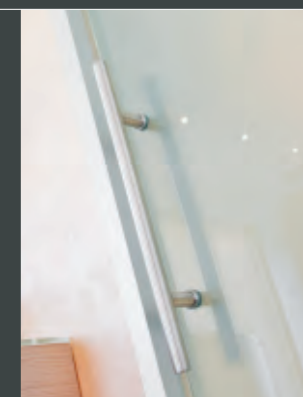

stilo 500

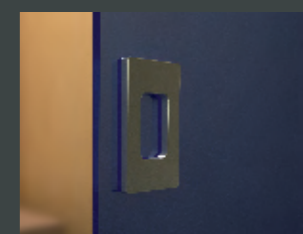

B93



5BN0

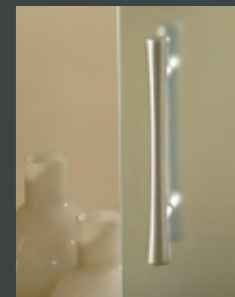

jazz





Realizzazione con porte d'arredo TEMA presso hotel  
**Hotel Pineta - MONSANO (AN)**  
Interior design - Andrea Sanchioni progetti

*range of TEMA internal doors in hotel  
**Hotel Pineta - MONSANO (AN)**  
Interior design - Andrea Sanchioni progetti*



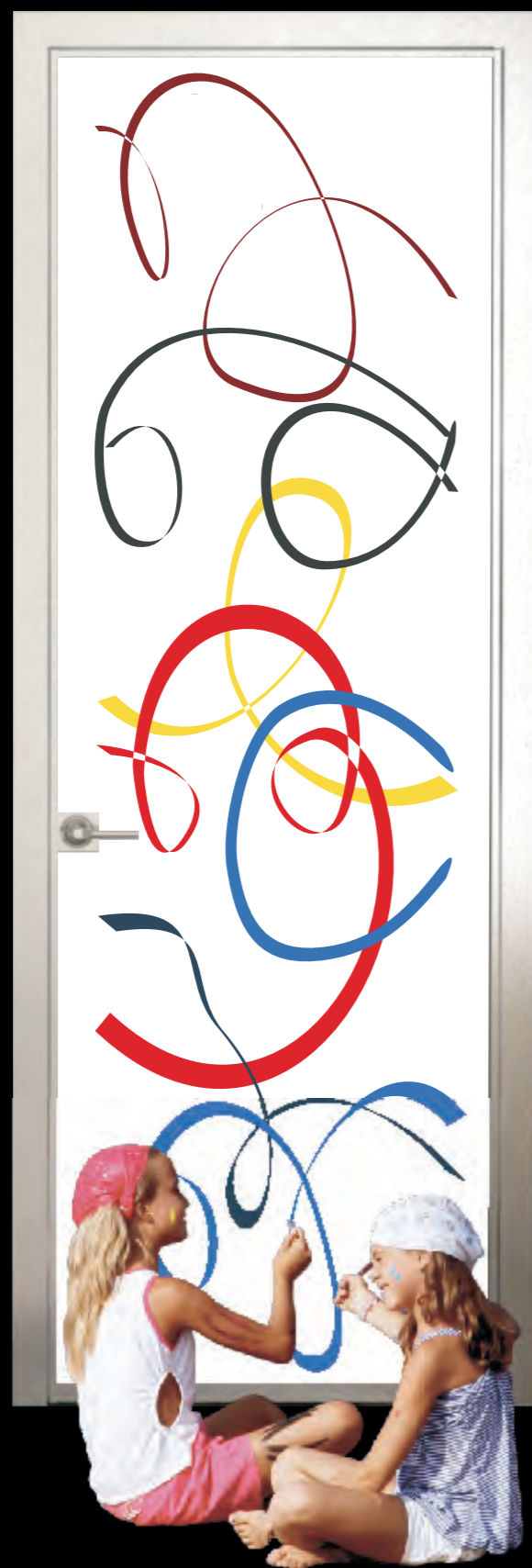

**tema**

P O R T E   A P E R T E   A L L A   C R E A T I V I T À



## foto scelta da te

Potete personalizzare la vostra porta richiedendo un vetro decorato con una vostra foto personale o scelta tra le tante immagini disponibili on-line. In questo secondo caso utilizzare immagini non coperte da diritti d'autore. In rete è possibile acquistare immagini a prezzi intorno ai 25 euro cad.; per esempio attraverso il sito [www.istockphoto.com](http://www.istockphoto.com).

La qualità della decorazione dipende dalla definizione dell'immagine stessa che consigliamo almeno 2800-2900 x 4000-4100 pixel.

Consigliamo inoltre di spedire direttamente l'immagine su CD al nostro indirizzo :  
TEMA s.r.l., Via Guazzi, sn. n° 61030  
Tavernelle di Serrungarina (PU)

## choose your own photo

*You can customize your door with your own personal photo or you can choose from the many images available on-line, just make sure they are not copyrighted. On the web you can buy images at prices around 25 euros each; take a look at [www.istockphoto.com](http://www.istockphoto.com) for example.*

*The quality of the decoration depends on the definition of the image that we recommend at least 2800 to 2900 x 4000 to 4100 pixels. Send your image directly to us on CD at our address:  
TEMA s.r.l., Via Guazzi, sn. – 61030  
Tavernelle di Serrungarina (PU)*





## vetri opachi

*external glass finishes*

- 01. temprato satinato bianco  
*tempered satin white*
- 02. temprato satinato bianco extrachiaro  
*tempered satin white extra clear*
- 03. temprato satinato bronzo  
*tempered satin bronze*
- 04. temprato satinato grigio  
*tempered satin grey*
- 05. stratificato satinato bianco  
*laminated satin white*
- 06. stratificato satinato nero  
*laminated satin black*
- 07. stratificato satinato rosso  
*laminated satin red*
- 08. stratificato satinato viola  
*laminated satin violet*
- 09. stratificato satinato giallo  
*laminated satin yellow*
- 10. stratificato satinato verde  
*laminated satin green*
- 11. stratificato satinato verde chiaro  
*laminated satin light green*
- 12. stratificato satinato blu  
*laminated satin blue*
- 13. stratificato satinato fucsia  
*laminated satin fuchsia*
- 14. stratificato satinato ambra  
*laminated satin amber*





## vetri lucidi

*internal glass finishes*

01. stratificato opalino  
*laminated opal*
02. stratificato bianco  
*laminated white*
03. stratificato bianco perla  
*laminated pearl white*
04. stratificato nero  
*laminated black*
05. stratificato marrone  
*laminated brown*
06. stratificato beige  
*laminated beige*
07. stratificato arancio  
*laminated orange*
08. stratificato rosso  
*laminated red*
09. stratificato verde  
*laminated green*
10. stratificato rosa  
*laminated pink*
11. stratificato fucsia  
*laminated fuchsia*
12. stratificato argento  
*laminated silver*
13. stratificato bordeaux  
*laminated bordeaux*
14. stratificato violetto  
*laminated violet*
15. stratificato blu notte  
*laminated blue night*
16. stratificato grigio  
*laminated grey*
17. stratificato giallo  
*laminated yellow*
18. specchio bifacciale  
*double face mirror*
19. temprato riflettente grigio  
*tempered reflecting grey*
20. temprato riflettente bronzo  
*tempered reflecting bronze*
21. temprato trasparente  
*tempered clear*
22. temprato extrachiaro trasparente  
*tempered extra clear*
23. temprato grigio trasparente  
*Tempered clear grey*
24. temprato bronzo trasparente  
*tempered clear bronze*



vetro 5+5 mm. temprato e stratificato nero  
 glass 5+5 mm. thick tempered and laminated black finish



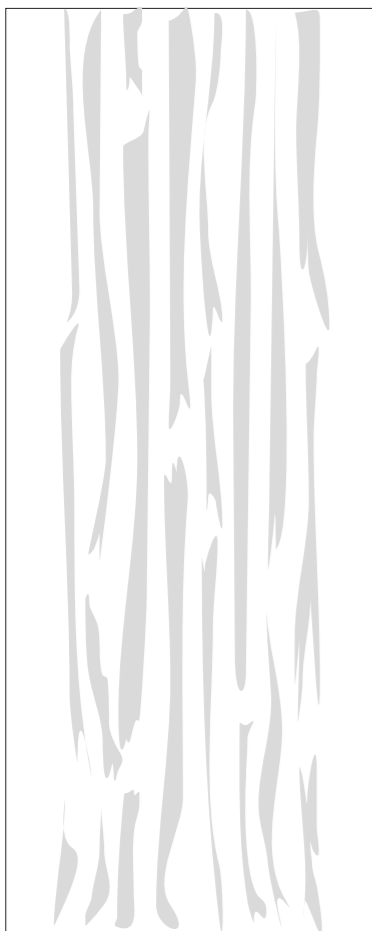

la fascia

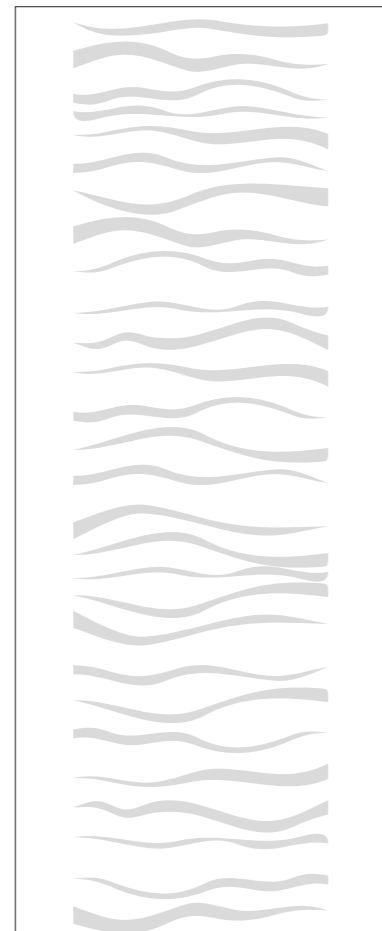

le onde



la tenda



l'orologio

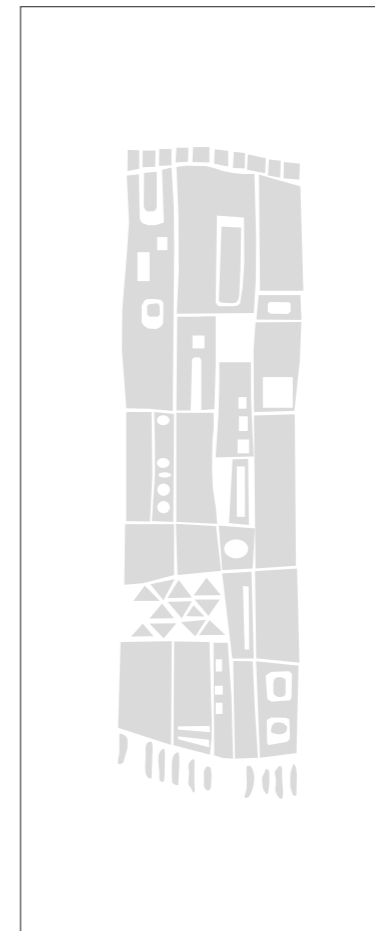

il tappeto



la foresta

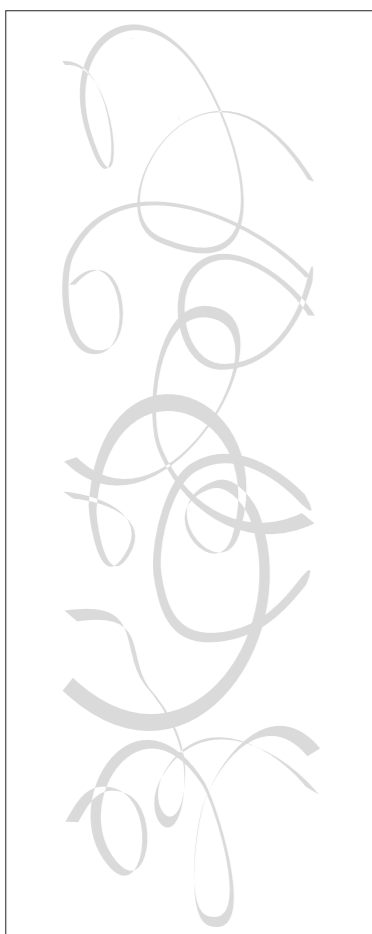

le curve



lo scarabocchio

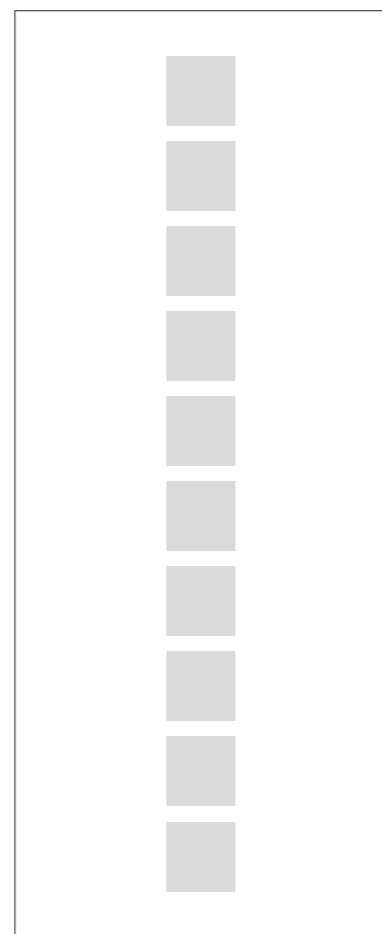

la colonna



l'albero 1



l'albero 2a

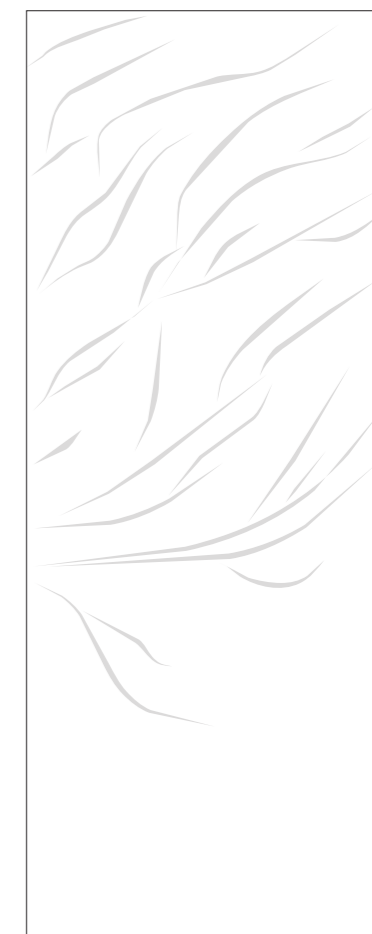

l'albero 2b



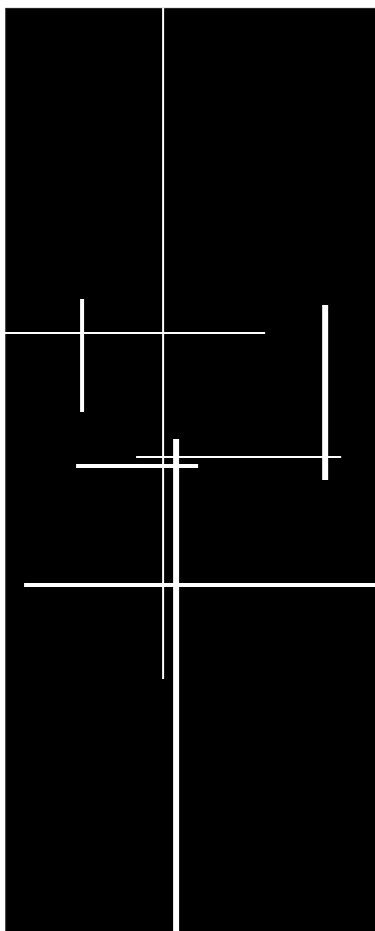

minimal 2 nero

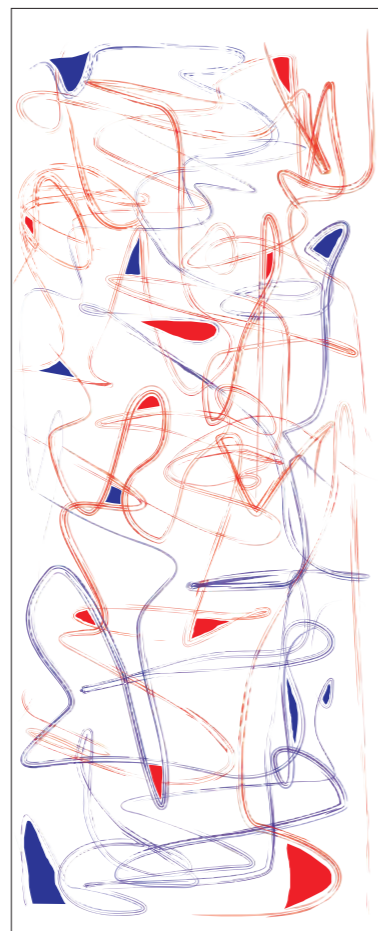

lo scarabocchio



Il bosco



la tristezza

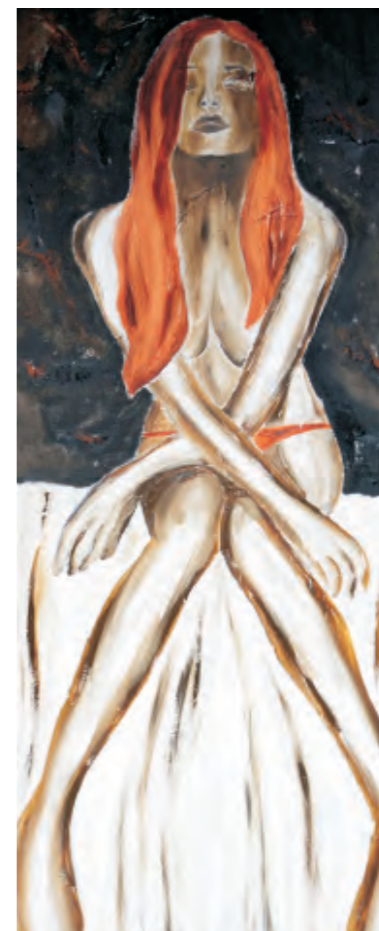

l'attesa



la fatica

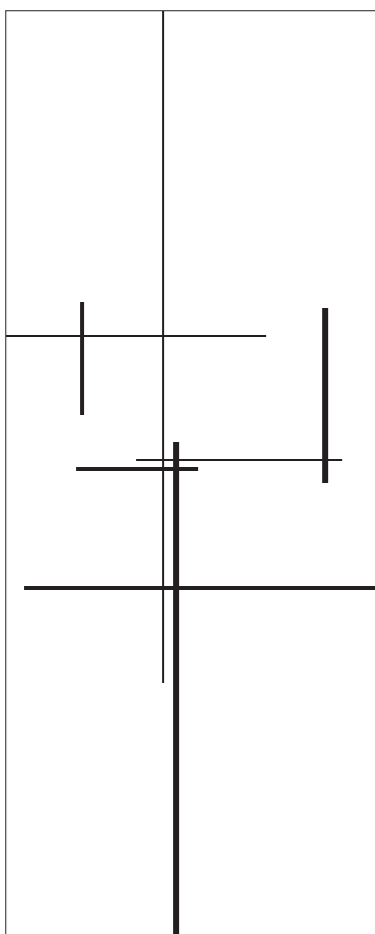

minimal 2 bianco

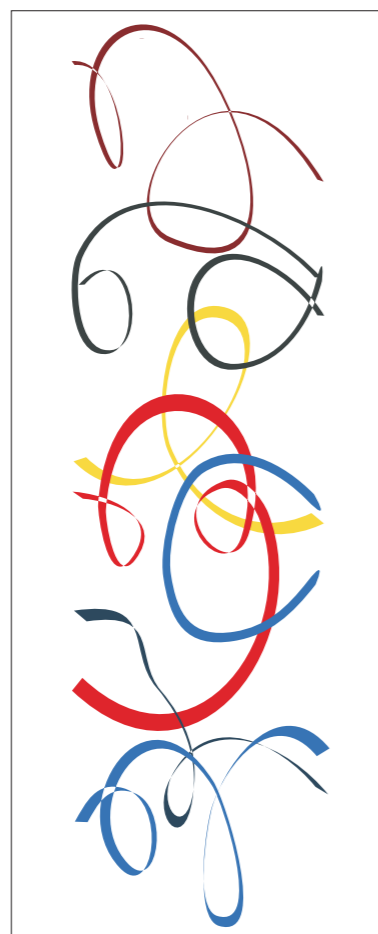

le curve



new york



geometria 2



dark roads



toro bianco





### finiture alluminio

#### argento opaco - piombo - nero - testa di moro

Finiture opache ottenute per anodizzazione conforme alle norme EN 12373, ISO 2370. La struttura della porta viene inoltre trattata con specifici prodotti al fine di risaltare la brillantezza e la luminosità stessa del metallo.

#### argento lucido - nichel

Finiture lucide ottenute per ossidazione anodica previa spazzolatura a lucido della superficie.

#### tinto legno rovere sbiancato

L'effetto legno si ottiene attraverso uno specifico processo di sublimazione che consente di ottenere riproduzioni estremamente fedeli alle caratteristiche tipiche del legno. La lavorazione consiste di due fasi ben distinte: verniciatura di rivestimento superficiale e sublimazione del rivestimento nelle essenze di legno desiderato.

#### bianco - bianco avorio

Finiture laccate ottenute per verniciatura con vernici antigraffio epossidiche in polvere e polimerizzate a forno. Su richiesta è possibile avere una vasta gamma dei colori RAL.

### aluminium finishes

#### ***matt silver – lead – black - dark brown***

*Matt anodized finishes conform to the EN 12373rd, ISO 2370 standards. The door frame is then specially treated to enhance the brilliance and brightness of the finish.*

#### ***polished silver – nickel***

*the polished finish is obtained by anodizing a previously brush polished finish.*

#### ***bleached oak***

*The surface is first painted and then a film of wood finish is applied to ensure a faithful reproduction of bleached oak.*

#### ***white - ivory***

*Lacquer finishes obtained by scratch-resistant epoxy powder coating. A wide range of RAL colours are available on request.*





## Salvino Bellavia

direzione artistica

## *Salvino Bellavia*

*art direction*

## Marco Bargnesi

fotografia

## *Marco Bargnesi*

*photo*

## Marco Laschi

modellazione 3D

## *Marco Laschi*

*3D modeling*

## Ideostampa

stampa

## *Ideostampa*

*print*

## si ringraziano per la cortese collaborazione

abitazione privata **Angeli Roberto** - RICCIONE (RN)

negozio espositivo **casa Berloni** - FANO (PU)

**Hotel Pineta** - MONSANO (AN)

**Studio Dentistico** Dr. Bacchiocchi - CASTELFIDARDO (AN)

## *we thank for the kind cooperation*

*private residence of Angeli Roberto* - RICCIONE (RN)

*show room* - **casa Berloni** - FANO (PU)

**Hotel Pineta** - MONSANO (AN)

**Dental Surgery** Dr. Bacchiocchi - CASTELFIDARDO (AN)

Le fotografie, i disegni, le illustrazioni, le finiture ed i colori di questo catalogo hanno valore indicativo. Tema s.r.l. declina ogni responsabilità per le possibili inesattezze contenute, dovute ad errori di stampa, di trascrizione o per qualsiasi altro motivo e si riserva il diritto di apportare modifiche, atte a migliorare i prodotti, senza preavviso. La riproduzione anche parziale è severamente vietata a norma di legge.

*All Photographs, designs, illustrations, finishes and colours in this catalogue are indicative only. Tema s.r.l. are not responsible or liable for any errors, inaccuracies or omissions from the use of this information. Tema s.r.l. does not warrant the accuracy or completeness of the content, all information is provided "as is" without any conditions, warranties, representations or other terms of any kind. Tema s.r.l. reserves the right to modify/change the information without prior notice. All content is subject to copyright and whole or part reproduction of such is prohibited by law.*



## **Tema s.r.l.**

Via Guazzi - 61030 Tavernelle di Serrungarina (PU)  
Tel. (+39)0721.892294 - Fax (+39)0721.878280

**[info@temadoors.it](mailto:info@temadoors.it)**

**[www.temadoors.it](http://www.temadoors.it)**